

PBM

SPECIFICATION FOR APPROVAL

Customer: Customer
Model No: PC40B2A250B
Motor Type: AC motor



PBM Motor and Fan (Suzhou) Co., Ltd

Website: www.pbmmf.com
<http://szbjd.en.made-in-china.com>
<http://pbmmf.en.alibaba.com>

EMAIL: XXX@pbmmf.com
TEL: 86-512-68581674
FAX: 86-512-68581574
CELL PHONE: 86-XXX
Factory: No.8, Zhu Street, Suzhou Industrial Park, Suzhou City, P. R. China 215121
Address: No.69, Weixin Road, Suzhou Industrial Park, Suzhou City, Jiangsu Province, P. R. China

Customer Approved

Customer

PBM Checked By

Daniel Luo

This specification defines the Mechanical and Electrical characteristics of the DC brushless external rotor motorized axial fan and backward curved impeller.

Model: PC40B2A250B

Motor: AC motor

◆ 1. General Characters

1-1	Rated Voltage	230 VAC
1-2	Frequency	50 Hz
1-3	Rated Speed	2500 RPM
1-4	Input Current	0.13 A
1-5	Input Power	18.5 W
1-7	Acoustical Noise	37 dB(A)
1-8	Life Expectance	30,000 Hours At nominal supply voltage, full speed room temperature 20°C.
1-10	Direction of Rotation	Clockwise seen on rotor
1-11	Dimension	See dimension drawing
1-12	Material of Impeller	Aluminum alloy
1-13	Air Flow	52.97 CFM / 90 m ³ /H
1-14	Static Pressure	1.94 mmH ₂ O / 19 Pa

◆ 2. Environmental Characters

2-1	Operating Temperature	-20°C to 70°C
2-2	Storage Temperature	-40°C to 80°C
2-3	RoHS	All the material meets RoHS standard.

Model: PC40B2A250B

Motor: AC motor

◆ 3. Performance Curve

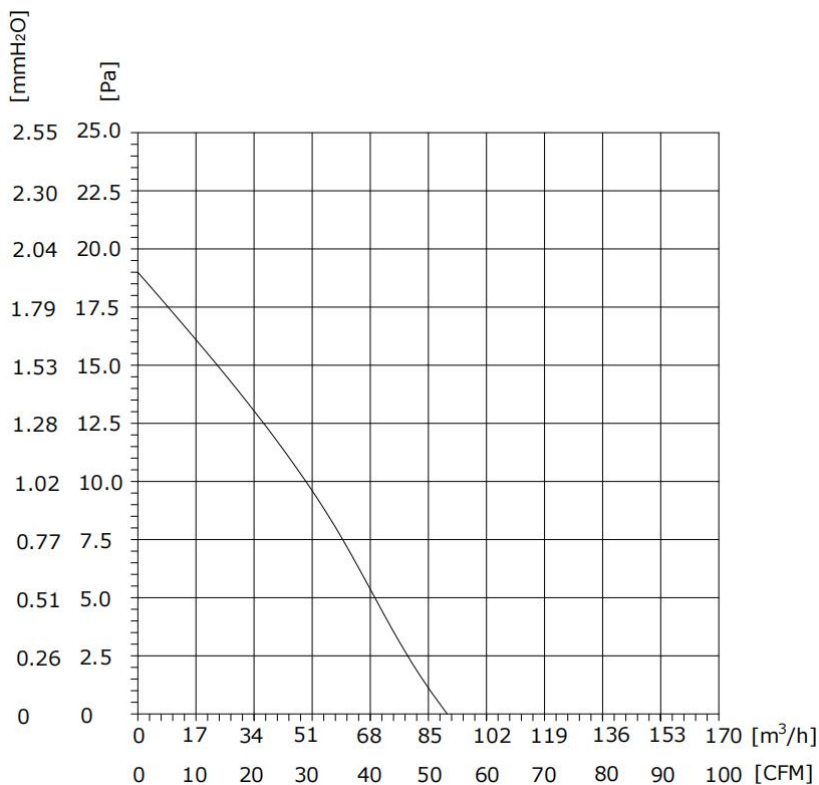

◆ 4. Outline Drawing

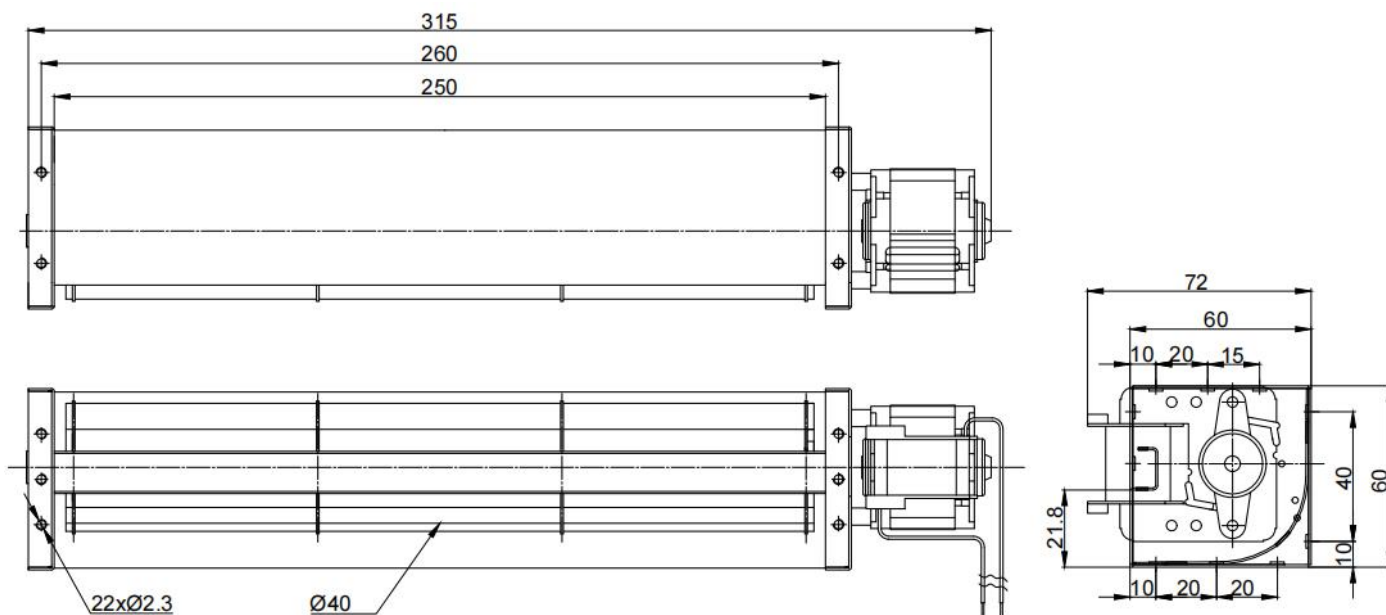

Model: PC40B2A250B

Motor: AC motor

◆ 5. Safety Requirements

1. Make sure that the metal casing of the stator connected to the ground before being powered on.
2. If the fan doesn't work after been powered on, please check the speed control input voltage, it may not be well connected. To prevent the suddenly start of the fan to hurt hands or other personal injury; do not touch the impellers or rotor when the power is on.
3. Fan needs a few seconds to start after being powered on. To prevent personal injury, do not touch the impellers or rotor when the power is on or in a low speed.
4. Unless they are instructed by the person(s) responsible for their safety, those who are lack of physical, mental or sensory capacities and proper practical experience or expertise cannot use this appliance. Please do not let the children play with this product.
5. If the power cord be damaged, the power cord must be replaced by the manufacturer in order to avoid accident of the proxy service personnel or the equivalent qualification maintenance personnel.
6. As an integral part of the fan, this DC motor cannot be used alone without impeller or load.
7. Please carefully read this technical specification before using the product.