

PBM

SPECIFICATION FOR APPROVAL

Customer:
Model No: **PC60B24245F**
Diameter of Impeller: **Ø60mm**



PBM Motor and Fan (Suzhou) Co., Ltd

www.pbmmf.com

<http://szpbd.en.made-in-china.com>

<http://pbmmf.en.alibaba.com>

Email:	XXX@pbmmf.com
TEL:	86-512-68581674
FAX:	86-512-68581574
Cell Phone:	86-XXX
Factory Add:	No.8, Zhu Street, Suzhou Industrial Park, Suzhou City, Jiangsu Province, P. R. China 215121
Office Add:	No.69, Weixin Road, Suzhou Industrial Park, Suzhou City, Jiangsu Province, P. R. China 215121

Customer Approved

PBM Checked By

Daniel Luo

Model: PC60B24245F
Diameter of Imeller: Ø60mm

◆ 1.General Characters

1-1	Rated Voltage	24 VDC
1-2	Operating Voltage	16 ~ 28 VDC
1-3	Rated Speed	2200 RPM
1-4	Input Current	0.55 A
1-5	Input Power	13.2 W
1-6	Acoustical Noise	45 dB(A)
1-7	Life Expectance	50,000Hours(L10) At 40°C room, humidity 15%~65%RH.
1-8	Direction of Rotation	Clockwise seen on motor
1-9	Insulation Class	Class B
1-10	Insulation Resistance	50 Mega Ohm minimum at 500VDC Between frame and (+) terminal
1-11	Motor Protection	Locked rotor protection Polarity protection Automatic restart capability
1-12	Speed Control	Control input 0~10VDC
1-13	Dielectric Strength	5mA maximum at 500VAC 50Hz five second Between frame and (+) terminal
1-14	Air Flow	99.46 CFM / 169 m ³ /H
1-15	Static Pressure	4.39 mmH ₂ O / 43 Pa
1-16	Protection Type	IP44

Model: PC60B24245F
Diameter of Impeller: Ø60mm

◆ **2. Mechanical Characters**

2-1	Dimension	90x98x307 (see dimension drawing)
2-2	Material of Impeller	Aluminum alloy
2-3	Number of Blades	22
2-4	Bearing System	NMB ball bearing
2-5	Mounting Position	Any
2-6	Lead Wire	Red , Black, White AWG22#
2-7	Package	Standard

◆ **3. Electrical Protection**

3-1	Locked-rotor Protection	Over-current limiting circuit protects motor from damage at least for 72 hours of locked rotor condition at rated voltage.
3-2	Reverse Polarity Protection	No damage if the positive and negative leads are reversed under maximum operation voltage conditions.
3-3	Over Voltage Protection	The circuit will be shut down automatically when input voltage over 15VDC. And re-started when Voltage down to 15VDC below.
3-4	Soft Start	In 5 seconds after power on and speed control voltage gets to 1.5V.
3-5	RoHS	All the material meets RoHS standard.

Model: PC60B24245F
Diameter of Imeller: Ø60mm

◆ **4. Environmental Characters**

4-1	Operating Temperature	-25°C to 60°C
4-2	Storage Temperature	-40°C to 75°C
4-3	Operating Humidity	5% to 90% RH
4-4	Storage Humidity	5% to 95% RH
4-5	RoHS	All the material meets RoHS standard.

◆ **5. Airflow Curve**

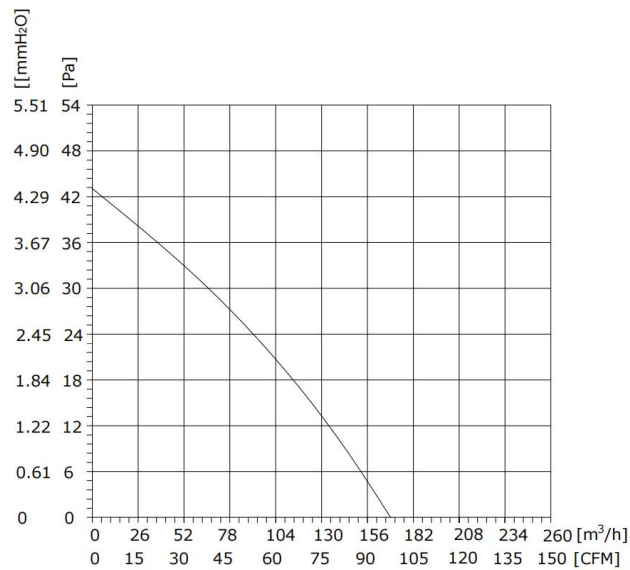

Testing Condition

Input Voltage----Operating voltage (24VDC)
 Temperature-----Room temperature
 Humidity-----65%RH
 Test distance-----1m

Model: PC60B24245F
Diameter of Imeller: Ø60mm

◆ **6. Outline Drawing**

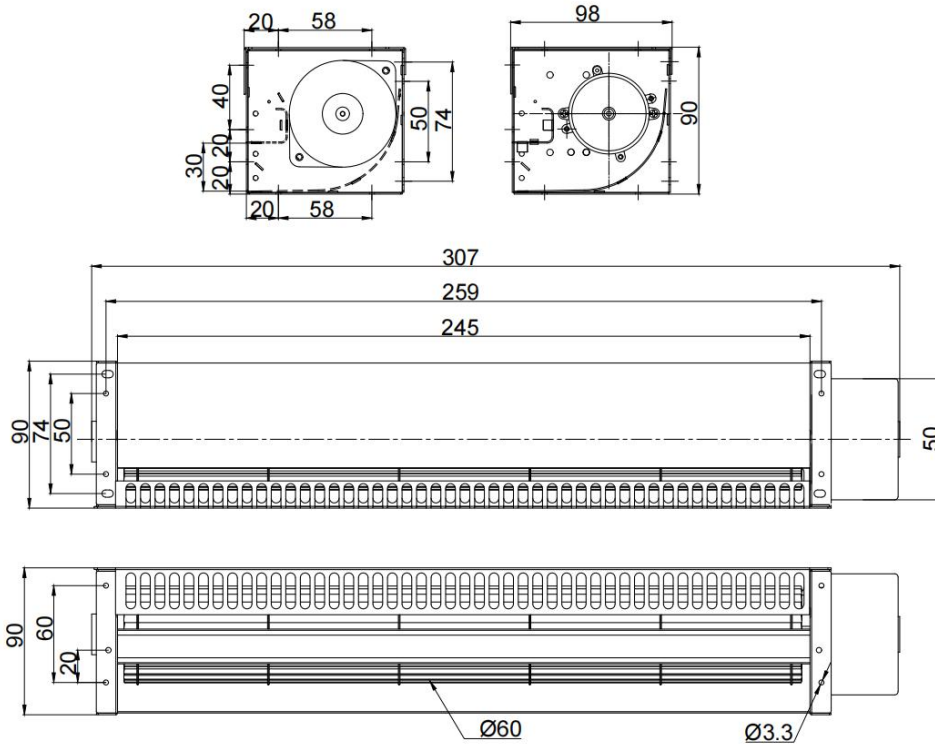

Note

1. Connection line 3X (Red, Black, White AWG22#);
 Red=+24VDC, White=0-10VDC, Blue=GND.

◆ **7. Connection Diagram**

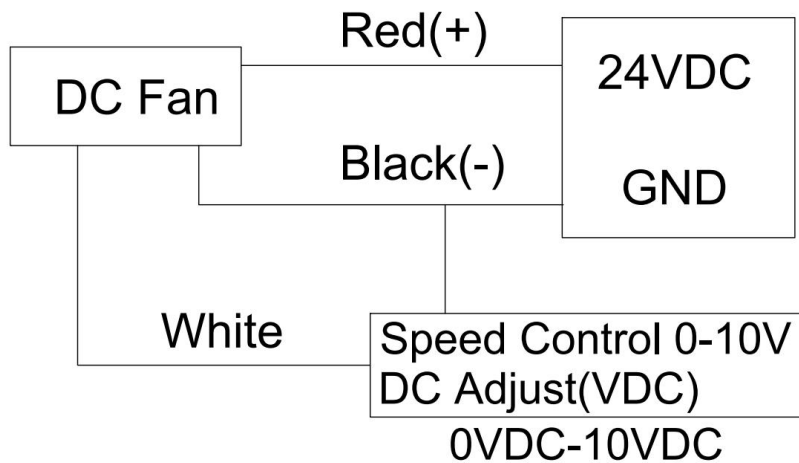

Model: PC60B24245F
Diameter of Imeller: Ø60mm

◆ **8.Safety Requirements**

1. Make sure that the metal casing of the stator connected to the ground before being powered on.
2. If the fan doesn't work after been powered on, please check the speed control input voltage, it may not be well connected. To prevent the suddenly start of the fan to hurt hands or other personal injury; do not touch the impellers or rotor when the power is on.
3. Fan needs a few seconds to start after being powered on. To prevent personal injury, do not touch the impellers or rotor when the power is on or in a low speed.
4. Unless they are instructed by the person(s) responsible for their safety, those who are lack of physical, mental or sensory capacities and proper practical experience or expertise cannot use this appliance. Please do not let the children play with this product.
5. If the power cord be damaged, the power cord must be replaced by the manufacturer in order to avoid accident of the proxy service personnel or the equivalent qualification maintenance personnel.
6. As an integral part of the fan, this DC motor cannot be used alone without impeller or load.
7. Please carefully read this technical specification before using the product.