

Model: PF3N200B24X

Motor: BE92DC

◆ 1.General Characters

1-1	Rated Voltage	24VDC
1-2	Operating Voltage	16~28 VDC
1-3	Rated Speed	1100 RPM
1-4	Input Current	2.2 A
1-5	Input Power	52.8 W
1-6	Air Flow	235.40 CFM / 400 m ³ /H
1-7	Static Pressure	0.48 inH ₂ O / 120 Pa
1-8	Acoustical Noise	45 dB(A)
1-9	Life Expectance	50,000 Hours(L10) At 40°C room, humidity 15%~65%RH.
1-10	Insulation Class	Class B
1-11	Motor Protection	Locked rotor protection Polarity protection Automatic restart capability
1-13	Speed Control	Control input 0~10VDC / PWM
1-14	Protection Type	IP44
1-15	Signal Output	FG (Frequency Generator)

Model: PF3N200B24X

Motor: BE92DC

◆ 2. Mechanical Characters

2-1	Dimension	Ø200mm X 130mm (see dimension drawing)
2-2	Material of Impeller	Galvanized Metal Shell
2-3	Number of Blades	38
2-4	Bearing System	NMB ball bearing
2-5	Lead Wire	AC(AWG20#), DC(AWG22 #)

◆ 3. Environmental Characters

3-1	Operating Temperature	-25°C to 60°C
3-2	Storage Temperature	-40°C to 75°C
3-3	Operating Humidity	5% to 90% RH
3-4	Storage Humidity	5% to 95% RH

Model: PF3N200B24X

Motor: BE92DC

◆ 4. Performance Curve

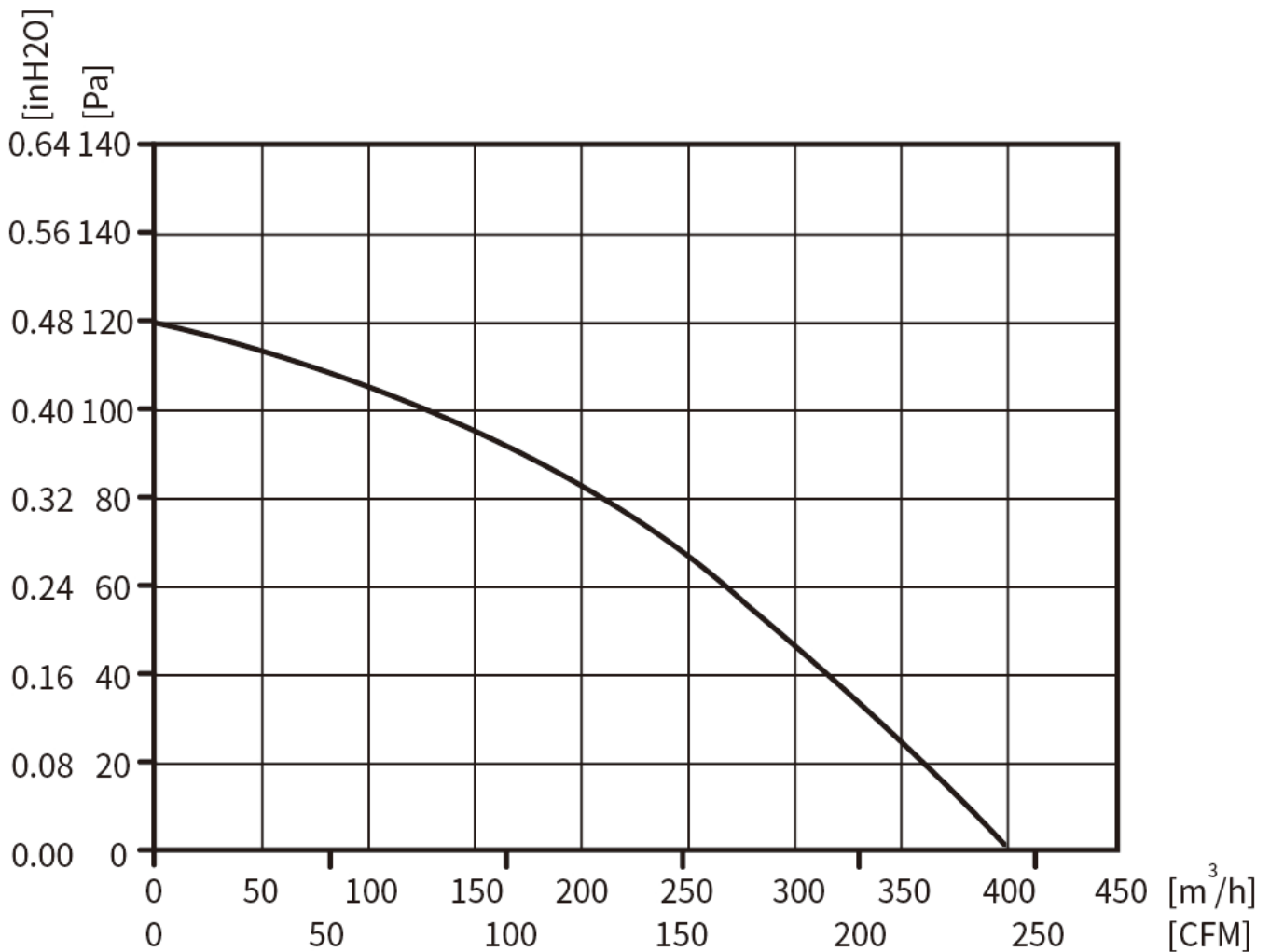

Testing Condition

Input Voltage----Operating voltage (24VDC)

Temperature-----Room temperature

Humidity-----65%RH

Model: PF3N200B24X

Motor: BE92DC

◆ 5. Outline Drawing

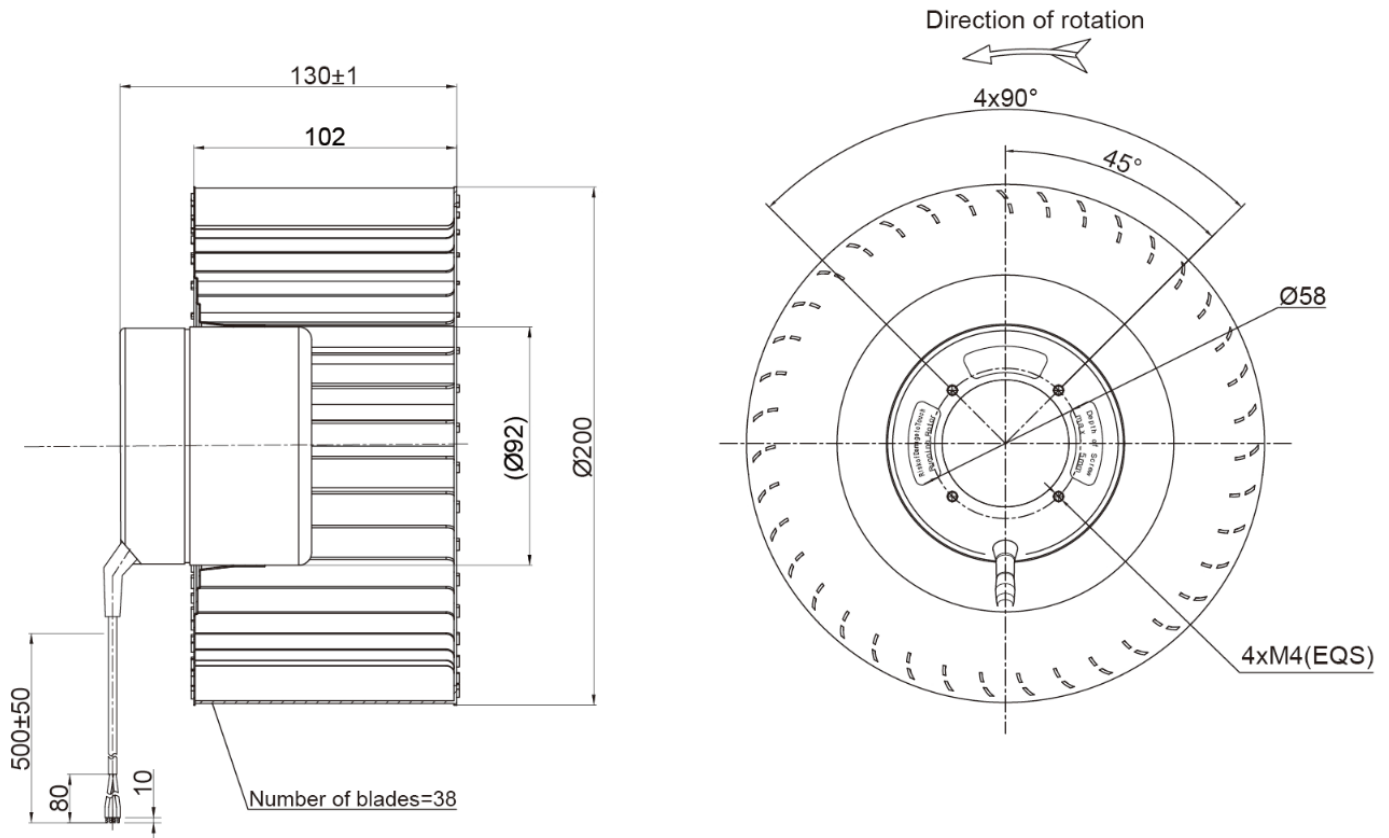

Note

- 1.Connection line:DC(4×AWG22#)
- 2.DC: Red=Voltage Input 24VDC, Yellow=0-10VDC/PWM, White=FG, Blue=GND;