

Model: PG3N250B2EM

Motor: BE92EC

◆ 1. General Characters

1-1	Rated Voltage	230 VAC
1-2	Frequency	50/60 Hz
1-3	Operating Voltage	184~276 VAC
1-4	Rated Speed	3000 RPM
1-5	Input Current	1.25 A
1-6	Input Power	180 W
1-7	Air Flow	1013.40 CFM / 1722 m ³ /H
1-8	Static Pressure	1.07 inH ₂ O / 268 Pa
1-9	Acoustical Noise	75 dB(A)
1-10	Life Expectance	50,000 Hours(L10) At 40°C room, humidity 15%~65%RH.
1-11	Insulation Class	Class B
1-13	Motor Protection	Locked rotor protection Polarity protection Automatic restart capability
1-14	Speed Control	Control input 0~10VDC / PWM
1-15	Protection Type	IP44
1-17	Signal Output	FG (Frequency Generator)

Model: PG3N250B2EM

Motor: BE92EC

◆ 2. Mechanical Characters

2-1	Dimension	Ø250mm X 115mm (see dimension drawing)
2-2	Material of Impeller	Cold rolled steel sheet
2-3	Number of Blades	7
2-4	Bearing System	NMB ball bearing
2-5	Lead Wire	AC(AWG20#), DC(AWG22 #)

◆ 3. Environmental Characters

3-1	Operating Temperature	-25°C to 60°C
3-2	Storage Temperature	-40°C to 75°C
3-3	Operating Humidity	5% to 90% RH
3-4	Storage Humidity	5% to 95% RH

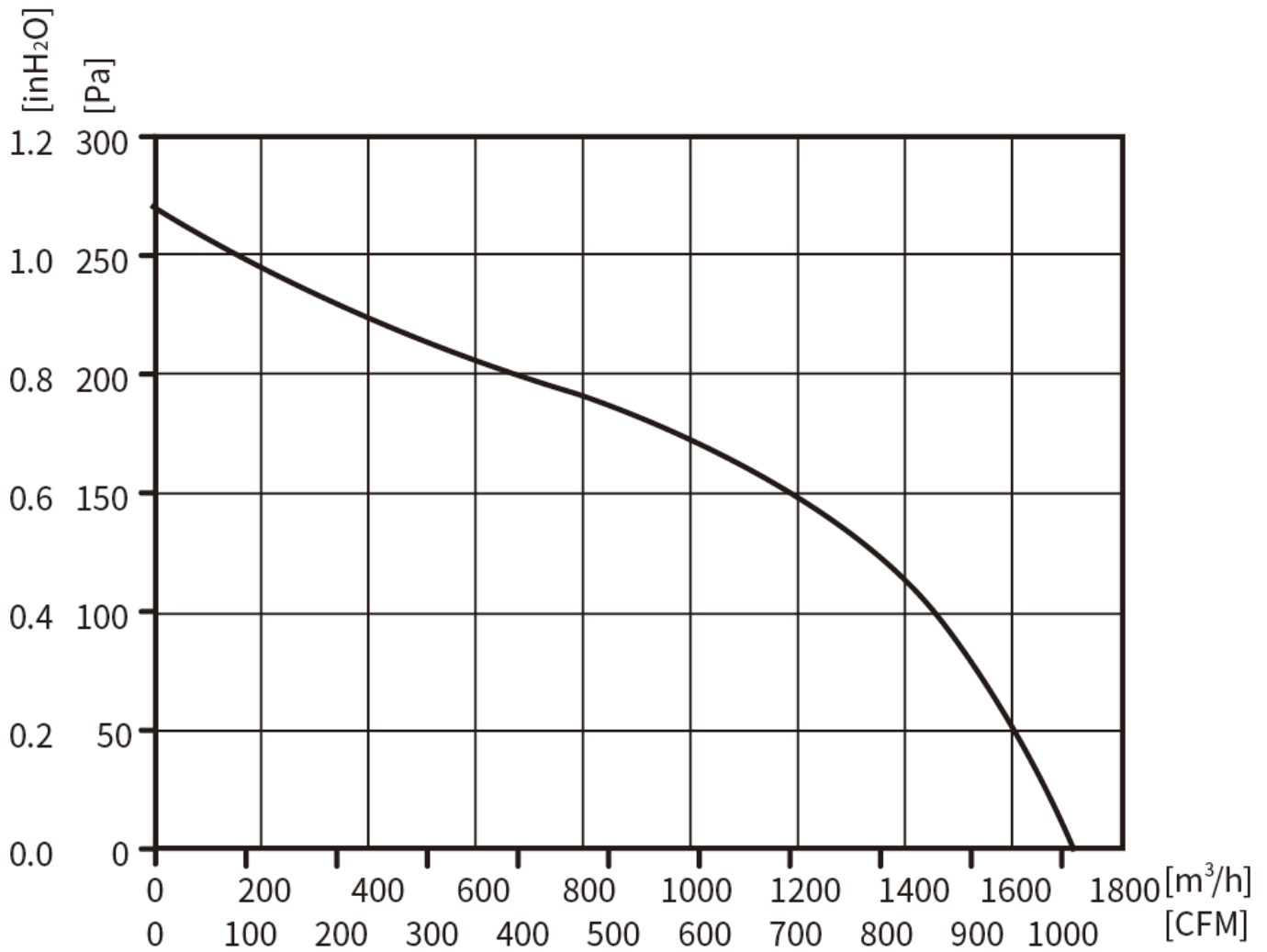
Model: PG3N250B2EM**Motor: BE92EC****◆ 4. Performance Curve****Testing Condition**

Input Voltage----Operating voltage (230VAC/50Hz)

Temperature-----Room temperature

Humidity-----65%RH

Model: PG3N250B2EM

Motor: BE92EC

◆ 5. Outline Drawing

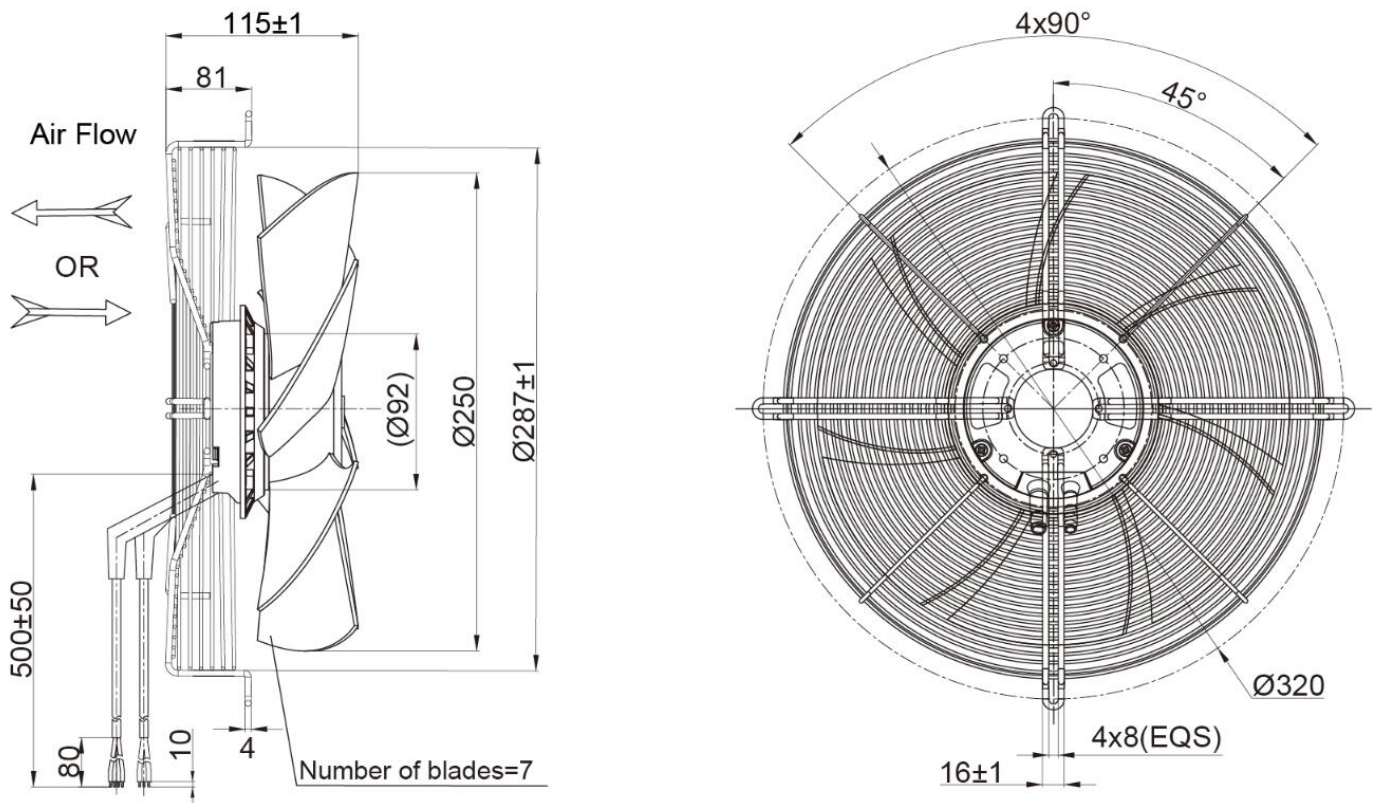

Note

- 1.Connection line: AC(3×AWG20#) , DC(4×AWG22#)
- 2.AC: Brown=Live Line , Blue=Null Line , Green & Yellow=Protecting Earthing;
- 3.DC: Red=Voltage Output +10VDC, Yellow=0-10VDC/PWM, White=FG, Blue=GND;